

Technical data sheet



Product features

Cooling counter 3D

Model	SAP Code	00013322
MT 903	A group of articles - web	Cooling and freezing tables



- Material: Stainless steel
- GN / EN size in device: GN 1/1
- Number of GN / EN: 3
- Number of doors: 3
- Minimum device temperature [°C]: 2
- Maximum device temperature [°C]: 8
- Max ambient temperature [°C]: 43
- Insulation thickness [mm]: 35
- Unit: Down
- Automatic defrost: Yes

SAP Code	00013322	GN / EN size in device	GN 1/1
Net Width [mm]	1365	GN device depth	150
Net Depth [mm]	700	Minimum device temperature [°C]	2
Net Height [mm]	875	Maximum device temperature [°C]	8
Net Weight [kg]	110.00	Refrigerant	R290
Power electric [kW]	0.240	Worktop material	SS201
Loading	230 V / 1N - 50 Hz	Refrigerant weight [g]	108.00
Energy class	C	Climate class	4
Chamber volume [l]	400	Worktop Thickness [mm]	35.00
Number of doors	3	Thickness back rim [mm]	1.50
Number of GN / EN	3		

Technical data sheet



Technical drawing

Cooling counter 3D

Model

SAP Code

00013322

MT 903

A group of articles - web

Cooling and freezing tables

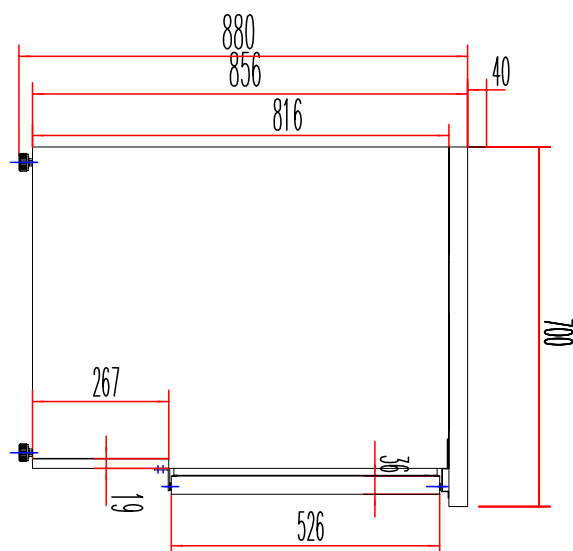
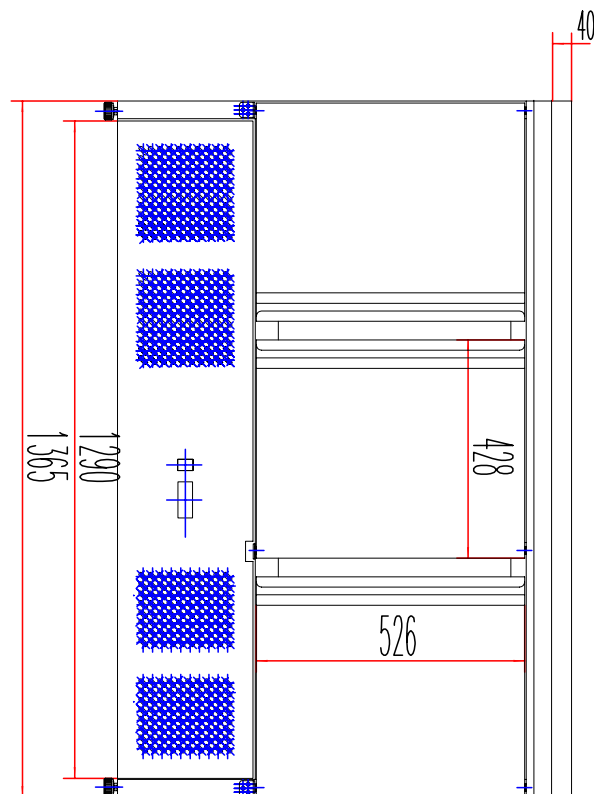

Technical data sheet



Technical parameters

Cooling counter 3D

Model	SAP Code	00013322
MT 903	A group of articles - web	Cooling and freezing tables

1. SAP Code:

00013322

2. Net Width [mm]:

1365

3. Net Depth [mm]:

700

4. Net Height [mm]:

875

5. Net Weight [kg]:

110.00

6. Gross Width [mm]:

1420

7. Gross depth [mm]:

765

8. Gross Height [mm]:

1095

9. Gross Weight [kg]:

130.00

10. Device type:

Electric unit

11. Power electric [kW]:

0.240

12. Loading:

230 V / 1N - 50 Hz

13. Energy class:

C

14. Refrigerant:

R290

15. Cooling type:

Static

16. Material:

Stainless steel

17. Exterior color of the device:

Stainless steel

18. Min ambient temperature [°C]:

18

19. Max ambient temperature [°C]:

43

20. Device properties 2:

Cooling

21. GN / EN size in device:

GN 1/1

22. Number of GN / EN:

3

23. GN device depth:

150

24. Chamber volume [l]:

400

25. Worktop material:

SS201

26. Insulation thickness [mm]:

35

27. Number of doors:

3

28. Unit:

Down

Technical data sheet



Technical parameters

Cooling counter 3D

Model	SAP Code	00013322
MT 903	A group of articles - web	Cooling and freezing tables

29. Annual energy consumption [kWh]:

1004

35. Gross Volume [m3]:

1.189

30. Minimum device temperature [°C]:

2

36. Net Volume [m3]:

0.836

31. Maximum device temperature [°C]:

8

37. Climate class:

4

32. Automatic defrost:

Yes

38. Worktop Thickness [mm]:

35.00

33. Refrigerant weight [g]:

108.00

39. Thickness back rim [mm]:

1.50

34. Number of grids:

3

40. Cross-section of conductors CU [mm²]:

0,5